

Data sheet | Item number: 769-673

THT male header; 1.0 x 1.0 mm solder pin; straight; Pin spacing 5 mm; 13-pole



769-673



RoHS Compliant

[BOMcheck.net](https://www.bomcheck.net)

Color: ■

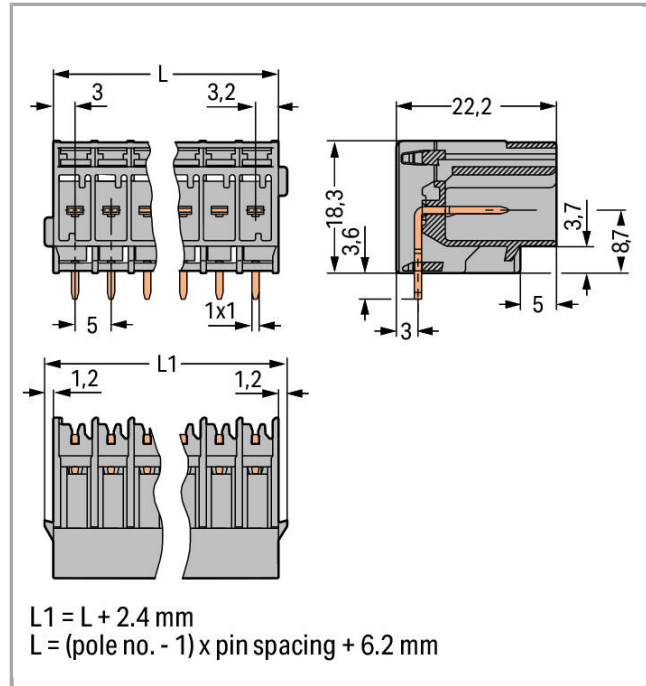

Data

Electrical data

Ratings per IEC/EN 60664-1

Rated voltage (III / 3)	250 V
Rated impulse voltage (III / 3)	4 kV
Rated voltage (III / 2)	500 V
Rated impulse voltage (III / 2)	4 kV
Rated current	32 A

Connection data

No. of poles	13
Total number of potentials	13
Number of levels	1

Geometrical Data

Pin spacing	5 mm / 0.197 inch
Width	68.6 mm / 2.701 inch
Height from the surface	18.3 mm / 0.72 inch
Depth	22.2 mm / 0.874 inch

Plug connection

Contact type (pluggable connector)	Male connector/plug
Connector connection type	for PCBs
Mismating protection	No
Mating direction to the PCB	0°

PCB contact

PCB contact	THT
-------------	-----

Material Data

Color	gray
Insulating material	Polyamide 66 (PA 66)
Fire load	0.276 MJ
Weight	13.919 g

Commercial data



Product Group	18 (X-COM-System)
Country of origin	DE
GTIN	4017332602532
Customs Tariff No.	85366990990

Approvals / Certificates



Country specific Approvals

Logo	Approval	Additional Approval Text	Certificate name
	CCA DEKRA Certification B.V.	EN 60947	NTR NL-7626
	CCA DEKRA Certification B.V.	IEC 61984	NL-47799
	CCA DEKRA Certification B.V.	EN 61984	2190419.02



	CSA DEKRA Certification B.V.	C22.2 No. 158	1101144
	KEMA/KEUR DEKRA Certification B.V.	EN 60947	2190419.01















UL-Approvals















Logo	Approval	Additional Approval Text	Certificate name
	UR Underwriters Laboratories Inc.	UL 1059	E45172
	UR Underwriters Laboratories Inc.	UL 1977	E45171

Compatible products

Female plug

	Item no.: 769-101 1-conductor female plug; 4 mm ² ; 1-pole		769-101
	Item no.: 769-102 1-conductor female plug; 4 mm ² ; 2-pole		769-102
	Item no.: 769-102/000-036 1-conductor female plug; 4 mm ² ; 2-pole	/000-036	769-102
	Item no.: 769-102/000-037 1-conductor female plug; 4 mm ² ; 2-pole	/000-037	769-102
	Item no.: 769-103 1-conductor female plug; 4 mm ² ; 3-pole		769-103
	Item no.: 769-103/000-036 1-conductor female plug; 4 mm ² ; 3-pole	/000-036	769-103

	Item no.: 769-103/000-037 1-conductor female plug; 4 mm ² ; 3-pole	/000-037	769-103
	Item no.: 769-103/000-038 1-conductor female plug; 4 mm ² ; 3-pole	/000-038	769-103
	Item no.: 769-103/000-039 1-conductor female plug; 4 mm ² ; 3-pole	/000-039	769-103
	Item no.: 769-104 1-conductor female plug; 4 mm ² ; 4-pole		769-104
	Item no.: 769-104/000-036 1-conductor female plug; 4 mm ² ; 4-pole	/000-036	769-104
	Item no.: 769-104/000-037 1-conductor female plug; 4 mm ² ; 4-pole	/000-037	769-104
	Item no.: 769-104/000-038 1-conductor female plug; 4 mm ² ; 4-pole	/000-038	769-104
	Item no.: 769-104/000-039 1-conductor female plug; 4 mm ² ; 4-pole	/000-039	769-104
	Item no.: 769-105 1-conductor female plug; 4 mm ² ; 5-pole		769-105
	Item no.: 769-105/000-036 1-conductor female plug; 4 mm ² ; 5-pole	/000-036	769-105
	Item no.: 769-105/000-037 1-conductor female plug; 4 mm ² ; 5-pole	/000-037	769-105
	Item no.: 769-105/000-038 1-conductor female plug; 4 mm ² ; 5-pole	/000-038	769-105
	Item no.: 769-105/000-039 1-conductor female plug; 4 mm ² ; 5-pole	/000-039	769-105
	Item no.: 769-106 1-conductor female plug; 4 mm ² ; 6-pole		769-106
	Item no.: 769-106/000-006 1-conductor female plug; 4 mm ² ; 6-pole	/000-006	769-106

	Item no.: 769-106/000-036 1-conductor female plug; 4 mm²; 6-pole	769-106 /000-036
	Item no.: 769-106/000-037 1-conductor female plug; 4 mm²; 6-pole	769-106 /000-037
	Item no.: 769-106/000-038 1-conductor female plug; 4 mm²; 6-pole	769-106 /000-038
	Item no.: 769-106/000-039 1-conductor female plug; 4 mm²; 6-pole	769-106 /000-039
	Item no.: 769-107 1-conductor female plug; 4 mm²; 7-pole	769-107
	Item no.: 769-107/000-036 1-conductor female plug; 4 mm²; 7-pole	769-107 /000-036
	Item no.: 769-107/000-037 1-conductor female plug; 4 mm²; 7-pole	769-107 /000-037
	Item no.: 769-107/000-038 1-conductor female plug; 4 mm²; 7-pole	769-107 /000-038
	Item no.: 769-107/000-039 1-conductor female plug; 4 mm²; 7-pole	769-107 /000-039
	Item no.: 769-108 1-conductor female plug; 4 mm²; 8-pole	769-108
	Item no.: 769-108/000-036 1-conductor female plug; 4 mm²; 8-pole	769-108 /000-036
	Item no.: 769-108/000-037 1-conductor female plug; 4 mm²; 8-pole	769-108 /000-037
	Item no.: 769-108/000-038 1-conductor female plug; 4 mm²; 8-pole	769-108 /000-038
	Item no.: 769-108/000-039 1-conductor female plug; 4 mm²; 8-pole	769-108 /000-039
	Item no.: 769-109 1-conductor female plug; 4 mm²; 9-pole	769-109
	Item no.: 769-109/000-036 1-conductor female plug; 4 mm²; 9-pole	769-109 /000-036



Item no.: 769-109/000-037
1-conductor female plug; 4 mm²; 9-pole

/000-037

769-109



Item no.: 769-109/000-038
1-conductor female plug; 4 mm²; 9-pole

/000-038

769-109



Item no.: 769-109/000-039
1-conductor female plug; 4 mm²; 9-pole

/000-039

769-109



Item no.: 769-110
1-conductor female plug; 4 mm²; 10-pole

769-110



Item no.: 769-110/000-036
1-conductor female plug; 4 mm²; 10-pole

/000-036

769-110



Item no.: 769-110/000-037
1-conductor female plug; 4 mm²; 10-pole

/000-037

769-110



Item no.: 769-110/000-038
1-conductor female plug; 4 mm²; 10-pole

/000-038

769-110



Item no.: 769-110/000-039
1-conductor female plug; 4 mm²; 10-pole

/000-039

769-110



Item no.: 769-111
1-conductor female plug; 4 mm²; 11-pole

769-111



Item no.: 769-111/000-036
1-conductor female plug; 4 mm²; 11-pole

/000-036

769-111



Item no.: 769-111/000-037
1-conductor female plug; 4 mm²; 11-pole

/000-037

769-111



Item no.: 769-111/000-038
1-conductor female plug; 4 mm²; 11-pole

/000-038

769-111



Item no.: 769-111/000-039
1-conductor female plug; 4 mm²; 11-pole

/000-039

769-111



Item no.: 769-112
1-conductor female plug; 4 mm²; 12-pole















769-112





















Item no.: 769-112/000-036
1-conductor female plug; 4 mm²; 12-pole

/000-036

769-112











	Item no.: 769-112/000-037 1-conductor female plug; 4 mm ² ; 12-pole	/000-037	769-112
	Item no.: 769-112/000-038 1-conductor female plug; 4 mm ² ; 12-pole	/000-038	769-112
	Item no.: 769-112/000-039 1-conductor female plug; 4 mm ² ; 12-pole	/000-039	769-112
	Item no.: 769-113 1-conductor female plug; 4 mm ² ; 13-pole		769-113
	Item no.: 769-113/000-036 1-conductor female plug; 4 mm ² ; 13-pole	/000-036	769-113
	Item no.: 769-113/000-037 1-conductor female plug; 4 mm ² ; 13-pole	/000-037	769-113
	Item no.: 769-113/000-038 1-conductor female plug; 4 mm ² ; 13-pole	/000-038	769-113
	Item no.: 769-113/000-039 1-conductor female plug; 4 mm ² ; 13-pole	/000-039	769-113
	Item no.: 769-113/021-000 1-conductor female plug; Locking lever; 4 mm ² ; 13-pole	/021-000	769-113
	Item no.: 769-114 1-conductor female plug; 4 mm ² ; 14-pole		769-114
	Item no.: 769-114/000-036 1-conductor female plug; 4 mm ² ; 14-pole	/000-036	769-114
	Item no.: 769-114/000-037 1-conductor female plug; 4 mm ² ; 14-pole	/000-037	769-114
	Item no.: 769-114/000-038 1-conductor female plug; 4 mm ² ; 14-pole	/000-038	769-114
	Item no.: 769-114/000-039 1-conductor female plug; 4 mm ² ; 14-pole	/000-039	769-114
	Item no.: 769-115 1-conductor female plug; 4 mm ² ; 15-pole		769-115

	Item no.: 769-115/000-036 1-conductor female plug; 4 mm ² ; 15-pole	769-115 /000-036
	Item no.: 769-115/000-037 1-conductor female plug; 4 mm ² ; 15-pole	769-115 /000-037
	Item no.: 769-115/000-038 1-conductor female plug; 4 mm ² ; 15-pole	769-115 /000-038
	Item no.: 769-115/000-039 1-conductor female plug; 4 mm ² ; 15-pole	769-115 /000-039
	Item no.: 769-121 2-conductor female connector; 4 mm ² ; 1-pole	769-121
	Item no.: 769-122 2-conductor female connector; 4 mm ² ; 2-pole	769-122
	Item no.: 769-123 2-conductor female connector; 4 mm ² ; 3-pole	769-123
	Item no.: 769-124 2-conductor female connector; 4 mm ² ; 4-pole	769-124
	Item no.: 769-125 2-conductor female connector; 4 mm ² ; 5-pole	769-125
	Item no.: 769-126 2-conductor female connector; 4 mm ² ; 6-pole	769-126
	Item no.: 769-127 2-conductor female connector; 4 mm ² ; 7-pole	769-127
	Item no.: 769-128 2-conductor female connector; 4 mm ² ; 8-pole	769-128
	Item no.: 769-129 2-conductor female connector; 4 mm ² ; 9-pole	769-129
	Item no.: 769-130 2-conductor female connector; 4 mm ² ; 10-pole	769-130
	Item no.: 769-131 2-conductor female connector; 4 mm ² ; 11-pole	769-131
	Item no.: 769-132 2-conductor female connector; 4 mm ² ; 12-pole	769-132
	Item no.: 769-133 2-conductor female connector; 4 mm ² ; 13-pole	769-133
	Item no.: 769-134 2-conductor female connector; 4 mm ² ; 14-pole	769-134
	Item no.: 769-135 2-conductor female connector; 4 mm ² ; 15-pole	769-135

Marking accessories

	Item no.: 210-831 Marking strips; on reel; 2.3 mm wide; plain; Self-adhesive	210-831
	Item no.: 210-832 Marking strips; on reel; 3 mm wide; plain; Self-adhesive	210-832
	Item no.: 210-833 Marking strips; on reel; 6 mm wide; plain; Self-adhesive	210-833
	Item no.: 210-834 Marking strips; on reel; 5 mm wide; plain; Self-adhesive	210-834

ferrule

	Item no.: 216-101 Ferrule; Sleeve for 0.5 mm ² / AWG 22; uninsulated; electro-tin plated	216-101
	Item no.: 216-102 Ferrule; Sleeve for 0.75 mm ² / AWG 20; uninsulated; electro-tin plated	216-102
	Item no.: 216-103 Ferrule; Sleeve for 1 mm ² / AWG 18; uninsulated; electro-tin plated	216-103
	Item no.: 216-104 Ferrule; Sleeve for 1.5 mm ² / AWG 16; uninsulated; electro-tin plated	216-104
	Item no.: 216-201 Ferrule; Sleeve for 0.5 mm ² / 20 AWG; insulated; electro-tin plated	216-201
	Item no.: 216-202 Ferrule; Sleeve for 0.75 mm ² / 18 AWG; insulated; electro-tin plated	216-202
	Item no.: 216-203 Ferrule; Sleeve for 1 mm ² / AWG 18; insulated; electro-tin plated	216-203
	Item no.: 216-204 Ferrule; Sleeve for 1.5 mm ² / AWG 16; insulated; electro-tin plated	216-204
	Item no.: 216-206 Ferrule; Sleeve for 2.5 mm ² / AWG 14; insulated; electro-tin plated	216-206
	Item no.: 216-301 Ferrule; Sleeve for 0.25 mm ² / AWG 24; insulated; electro-tin plated	216-301
	Item no.: 216-302 Ferrule; Sleeve for 0.34 mm ² / 22 AWG; insulated; electro-tin plated	216-302

Coding

	Item no.: 769-435 Coding pin; for coding of female plugs; for carrier terminal blocks / male connectors	769-435
--	---	---------

Downloads
Documentation
Bid Text

769-673



doc	Download
25.6 kB	

CAD/CAE - Smart Data

CAD data

3D Download 769-673	URL	Download
---------------------	-----	----------

Product family

X-COM

[Learn more about the product family.](#)

[Show all products from the family](#)

Subject to changes.
